

Anchoring systems for geotechnical engineering



D E S I G N , B U I L D , M A I N T A I N



FREYSSINET
SUSTAINABLE TECHNOLOGY

INTRODUCTION

Ground anchors were one of the first applications of Freyssinet's technologies. In 1939, Eugène Freyssinet used prestressed anchors, together with flat jacks, to stabilise the Beni Bahdel dam in Algeria.

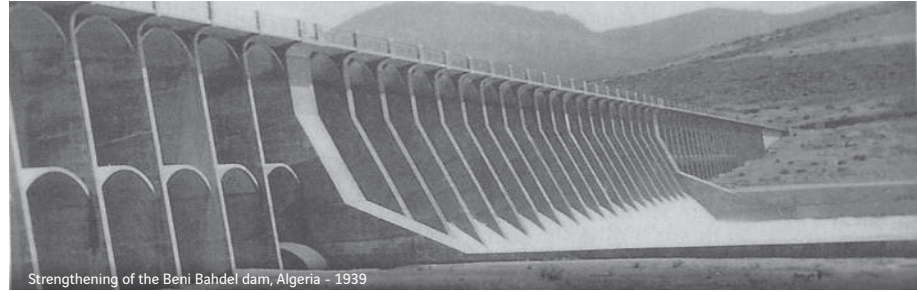

Strengthening of the Beni Bahdel dam, Algeria - 1939

Ever since, technological developments have pushed back the boundaries in this field. The realm of possibilities has increased significantly, enabling both designers and builders to safely and effectively overcome the technical challenges inherent in the environment.

Conscious of the trends shaping demand and the market, Freyssinet has considerably expanded its geotechnical engineering range over the past few years.

With more than 70 years' experience in soil structure, together with an accredited production force that complies with international standards, Freyssinet designs, manufactures and supports companies on-site.

We can draw on our expertise at every stage in the process to deliver superior performance and future-proof our work.

Freyssinet can provide its expertise and skills to drive your current and future projects:

- Products are developed and then manufactured in modern workshops by skilled workers. Quality is the keyword at every stage in the manufacturing process, and all products undergo exhaustive tests to guarantee best-in-class performance.
- Freyssinet offers anchoring solutions and associated services to companies engineering special foundations and carrying out strengthening work to ensure structural stability and reinforce the ground.
- Freyssinet can advise companies and project managers on structural design, installation methods and specialised technologies. Because each customer is unique, our group of experts provides you with exactly the right solutions for your requirements.

A key player in geotechnics, we pursue an active research and development policy, and our main aim is to gain a clear insight into each customer's requirements in a bid to deliver the best-fit solutions.



Rosa Parks station, Paris, France - 2012

The Freyssinet Group

Freyssinet brings together **an unrivalled range of expertise in the specialist civil engineering sector**. It implements solutions with high added value in two major fields: construction and repairs.

Freyssinet is involved in numerous projects across five continents, making it the world leader in its specialist areas of:

- Prestressing
- Construction methods
- Cable-stayed structures
- Structural accessories
- Repairs
- Structural reinforcement and maintenance

Freyssinet is highly involved in sustainable development issues and has set up a number of initiatives, particularly to reduce the environmental impact of its projects and enhance its social responsibility policy.

Freyssinet is a subsidiary of the Soletanche Freyssinet Group, a world leader in the soils, structures and nuclear sectors.

*Cover photo:
Rosa Parks station - Paris, France*

Contents

Areas of application	p3
Freyssinet steel tendons	p4
Stages in the implementation process	p5
Ground anchors	p6
Soil nails and rock bolts	p6
Micropiles	p7
Port tie rods	p7
Freyssinet strand anchors	p8
Freyssibar anchors	p10
Freyssi500-E, Freyssi670-E and Freyssi500 systems	p12
FreyssiSD system	p14
FreyssiCell system	p15
Injection systems	p16
Associated services	p17
References	p18
Production and quality	p19

AREAS OF APPLICATION

Anchors are used in all areas of construction.

Excavation

The anchor ensures that the ground remains stable and allows for deep, wide excavations. It is often temporary, because the long-term stability of the ground is maintained by the structure built in the excavation (car parks, basements, etc.)

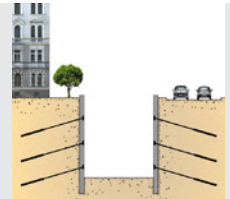

Slope stabilization

Installing anchors at an angle prevents landslides and improves ground resistance.

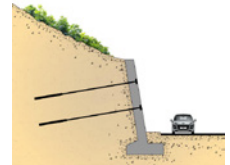

Dams

Vertical anchors are generally prestressed and improve dams' rollover resistance, while reducing water seepage along the line of contact with the rock.

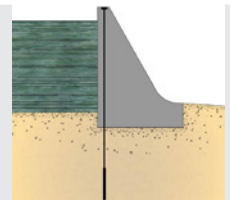

Quay walls

Port tie rods keep a quay wall stable by transferring the forces to a rear sheet pile wall. This principle is also used for backfill held in place by prefabricated walls (access ramps, etc.)

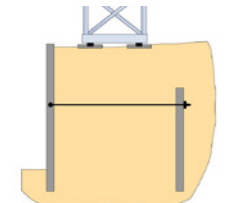

Underground

Anchoring techniques strengthen retention of the galleries by balancing the forces of the ground. This type of application is found in mines and tunnels.

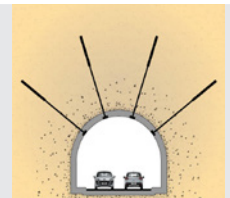

Anchoring structures

Vertical anchors provide an effective link between the foundation and the ground, while curbing the effects of fatigue when prestressed. Anchors can be used for towers, radio masts, wind turbines, etc.

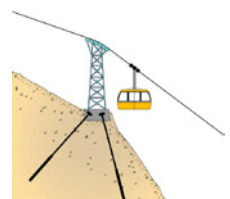

Foundations

Anchors enable structures to be built on land with a low bearing capacity or unstable land. The vertical loads of the structure are transmitted to the deeper, stable areas.

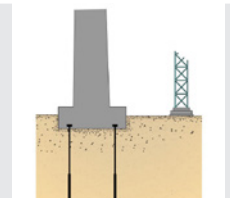

Hydrostatic uplift loads

Corrosion-resistant anchors are used to hold structures in place that are subject to significant water uplift pressure and therefore enable structures to be built in wet areas by compensating for the principle of Archimedes.



There are several families of anchors for these different applications:





- Ground anchors
- Soil nails and rock bolts
- Micropiles
- Port tie rods

FREYSSINET STEEL TENDONS

Freyssinet has a wide range of tendons for designing anchors geared towards each application.

Applications	Strand	Freyssibar	Freysssi500 / Freysssi500-E	Freysssi670-E	Freysssi SD
Ground anchors	X	X	X	X	X
Soil nails and rock bolts			X	X	X
Micropiles		X	X	X	X
Port tie rods	X		X	X	

Tendons specifications

Steel tendon	Diam. (mm)		Min. cross-section mm ²	Min. weight kg/m	Ultimate strength N/mm ²	Ultimate load kN	Yield strength N/mm ²	Yield load kN	Average Young modulus N/mm ²	
	Nom.	Ext.								
Prestressing strand 	<i>p 8-9</i>	T12.5	12.5	93	0.73	173		152	195,000	
		T12.9	12.9	100	0.78	186		164		
		T15.3	15.3	140	1.10	260	1,860	1,650		229
		T15.7	15.7	150	1.18	279		246		
Freyssibar 	<i>p 10-11</i>	26.5	28.8	552	4.56	568		461	170,000	
		32	34.5	804	6.66	828		672		
		36	38.6	1,018	8.45	1,048	1,030	835		850
		40	43.4	1,257	10.41	1,295		1,049		
		50	53.2	1,964	16.02	2,022		1,640		
Freysssi 670-E 	<i>p 12-13</i>	22	23.8	375	2.94	300		251	210,000	
		25	27.3	491	3.85	393		329		
		28	30.6	616	4.83	493		413		
		30	33.0	707	5.55	566	800	670		474
		35	38.3	962	7.55	770		645		
		43	46.8	1,452	11.40	1,162		973		
		57.5	61.5	2,597	20.38	2,078		1,740		
63.5	67.8	3,167	24.86	2,534		2,122				
Freysssi 500 / Freysssi 500E 	<i>p 12-13</i>	20	22.1	314	2.47	173		157	210,000	
		25	27.6	491	3.85	270		246		
		28	30.9	616	4.83	339	550	500		308
		32	35.4	804	6.31	442		402		
		40	43.9	1,257	9.87	691		629		
		50	54.3	1,963	15.40	1,078		982		
		63.5	67.9	3,167	24.86	2,217	700	550		1,758
Freysssi SD 	<i>p 14</i>	R25N	25	250	2.00	200		150	190,000	
		R32N	32	350	2.70	280		230		
		R32S	32	430	3.40	360		280		
		R38N	38	590	4.70	500		400		
		R51L	51	740	5.90	550	600 to 850	500 to 680		450
		R51N	51	940	7.40	800		630		
		T76L	76	1,650	12.90	1,200		1,000		
		T76N	76	2,080	16.30	1,600		1,200		
		T76S	76	2,460	19.30	1,900		1,500		

STAGES IN THE IMPLEMENTATION PROCESS

Freyssinet offers best-fit solutions at every stage of the project. The constraints inherent in implementation are an integral part of product and system design.

Prefabrication and transport

Anchors are made using bars or strands, on which accessories are mounted (sheaths for the free length, injection pipe for grouting, centring devices, etc.). The corrosion protection systems are produced in the factory to ensure maximum quality and effectiveness. Appropriate packaging protects the products and ensures their safety during transport.



Drilling

The bore hole (diameter generally between 50 and 200 mm) is performed using tools and drilling fluid suitable for the ground. All angles are possible and are determined by the stresses of the structure and the ground. The bore hole must enable the anchor to be inserted in the ground. It has a major impact on the final strength of the grouting. The composition of the anchors must take account of the drilling method, the diameter and the angle (solution for centring the tendon in the hole, location of the injection system in relation to the tendon, etc.).



Installation in the drill hole and injection

The anchor is inserted in the bore hole using the appropriate equipment, such as lifting beams, uncoilers and cranes, or in some cases manually. Once the anchor is in place, the grouting compound, generally a high dose cement grout, is injected into the bore hole using an injection pipe. There are several injection methods to suit the different types of ground encountered (see page 16).



Tests

Tensile testing is essential. Some tests are carried out at the start of the project on disposable anchors to confirm that the design assumptions for the preliminary sizing of the bonding are adequate. Other non-destructive tests are carried out on the anchors incorporated in the structure. Specialist Freyssinet technicians work on-site to carry out these operations in line with the applicable standards for the type of anchor and the country. Compliance with these standards is vital to the success of a project (see page 17).



Tensioning

On prestressed anchors (ground anchors or rock bolts), tensioning is carried out 1 to 7 days after injection, depending on the type of ground and the grouting compound used. A jack is used to apply the tension. During this operation, a test traction is applied to each anchor to confirm the satisfactory performance of the bonding. Special equipment and specialist technicians are needed to carry out this sensitive operation.



Final protection

The final protection of the anchor head is provided by filling the empty spaces around the tendon with appropriate products (grease, wax and cement grout). The metal parts are also treated against corrosion according to the environment and in line with applicable standards.



GROUND ANCHORS

Ground anchors are used for tensile stress. They transmit the forces from a structure (wall, foundation, etc.) to the ground in which they are anchored. They are generally prestressed.

Two operating principles

Retaining

The ground anchor can be used to stabilise a retaining wall by transferring the forces caused by the natural thrust of the ground and the working loads beyond the slip circle. Forces are transmitted to the ground via the bond length. It is generally prestressed to control the movement of the wall during the various construction phases.

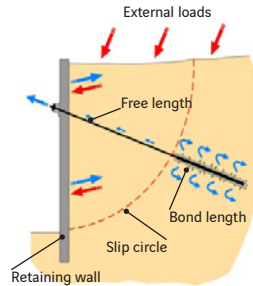

Anchoring structures

The purpose of the ground anchor is to generate a force across a structure, either to compensate for an uplift force or compress the foundation on the ground. It must mobilise a volume of ground with a sufficient weight to offset the required force. The bond length is designed to transmit the forces to the ground, and the free length is defined according to the required volume of ground. The prestressing force plays a vitally important role in reducing or preventing vertical movement. In case of repeated forces, it eliminates the risks of fatigue on the bonding.

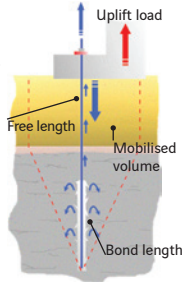

The different parts of the ground anchor

Prestressing force

This may be lower than the working force of the ground anchor. It is defined according to the acceptable movement of the structure.

Anchor head

This alone provides the mechanical link between the anchor body and the structure. Special attention must be paid to its strength and durability.

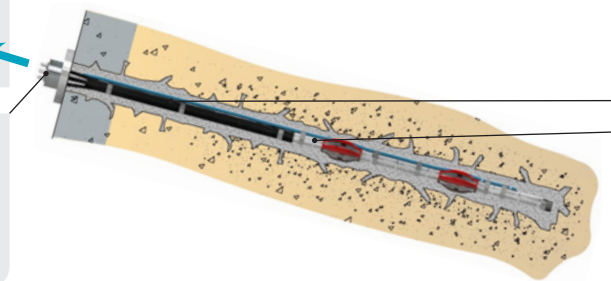

Free length

This is between the head of the ground anchor and the start of the bond length. It allows for elongation of the cable during tensioning and transmission of the forces to the bond length.

Bond length

This transmits the force to the ground at the depth defined by the project designer. The force is transmitted by the anchoring, which is created by injecting cement grout into the ground.

SOIL NAILS & ROCK BOLTS

Most of the time, these anchors are created using bars inserted in a bore hole and held in place using grouting or a mechanical anchor. Their purpose is to improve the resistance of the ground.

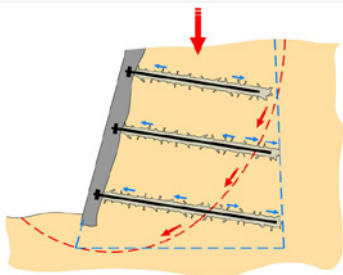

Soft ground: soil nails

Soil nails are 20 to 50 mm diameter bars, inserted in 70 to 150 mm bore holes. They are generally over 6.00 m long and may be as much as 20 m. They are bonded along their entire length by cement grouting. They are said to be "passive" and are subjected to tensile, bending and shear stresses by the movement of the ground.

In mines - The bolts reinforce the roof of the cavity to recreate a beam effect with the natural earth.

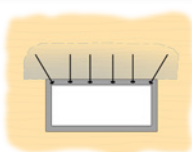

In tunnels - The bolts reinforce the natural earth on the roof to create an arched effect.

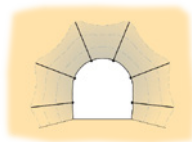

On cliffs - The bolts stabilise the blocks to limit erosion. They can also be used to anchor the stone and rockfall mesh.

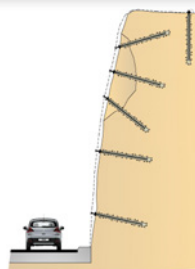

Rock: rock bolts

Rock bolts are 15 to 32 mm diameter bars, inserted in 30 to 60 mm bore holes. They are generally between 3.00 and 6.00 m long. They may be bonded along their entire length by cement grouting or anchored at various points at the base of the hole using resin or a mechanical anchorage.

Anchors with continuous grouting are said to be "passive" and are subjected to tensile and shear stresses by the movement of the ground. Bolts with grouting at various points (resin or plug) are often prestressed by tightening with a wrench or a jack.

MICROPILES

Micropiles are used to strengthen existing foundations or create a deep foundation for new structures.

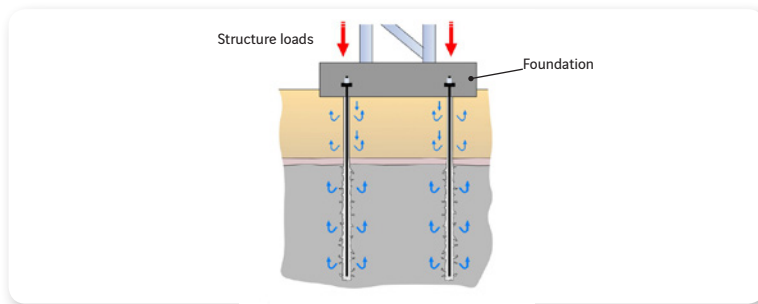

A foundation element

Micropiles are a foundation element by transferring the loads exerted by a structure to a foundation in supporting ground. They mainly work by friction to take up the compression and/or tensile forces. As with other anchors, it is the combination of the bore hole diameter, the injection method and the characteristics of the ground that are used to define the bearing capacity.

Component parts of the micropile

Micropiles may comprise one or more reinforcements:

- A single bar
- A bundle of several bars (generally three)
- A bar contained in a metal tube

In all cases, bars can be joined using couplers and will be fitted with spring baskets.

An injection pipe suitable for the required injection method will be installed along the reinforcement.

It is connected to the foundation using an assembly of plates and nuts or lock nuts, carefully positioned according to the direction of the forces.

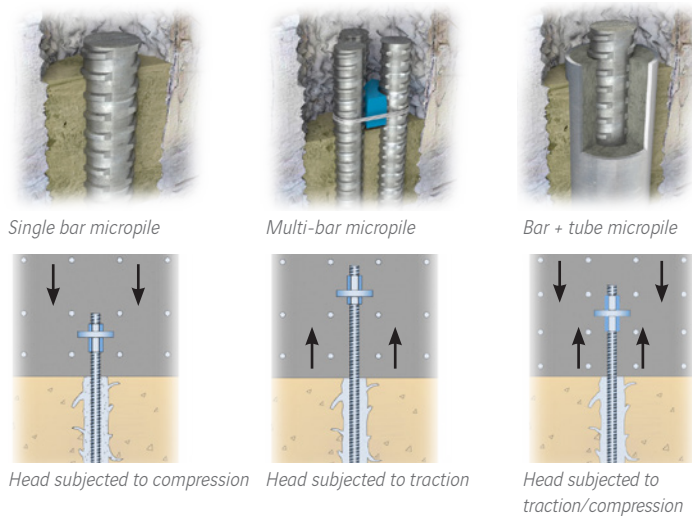

PORT TIE RODS

A sea or river quay generally consists of backfill contained between the quay wall and a rear sheet pile wall. The stability of the whole structure is provided by the tie rod.

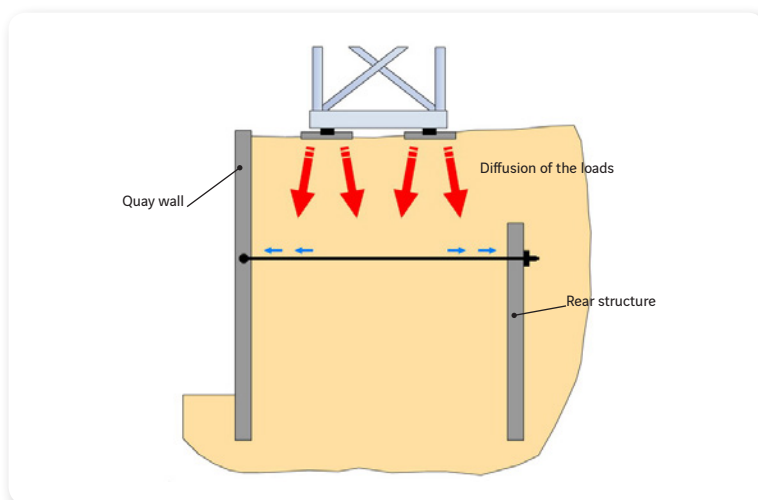

A structural element

The port tie rod links a quay wall (diaphragm wall, sheet pile wall, etc.) to a rear structure (pile, sheet pile wall, etc.).

The forces exerted on the quay wall by the natural thrust of the ground and the working loads are transmitted to the tie rod which, subjected to tensile stress, transfers these forces to the rear structure, which is itself subject to thrust due to the working loads. The tie rod therefore contains the forces in a block of ground defined by the wall and the rear structure.

The tension on the tie rod comes from the backfill and the application of the working loads. The movements of the ground result in bending and shear stresses on the tie rod, which often require the installation of hinged anchors.

These tie rods can be made up of passive bars (in this case, fairly low steel grades are used to limit the elongation) or strands (in this case they will be prestressed).

FREYSSINET STRAND ANCHORS

Categories

Ground anchors are defined by their protection class and their injection type for bonding. They may be temporary (short service life), semi-permanent (medium service life) or permanent (long service life), which defines their corrosion protection level. The position of the strands in relation to one another is defined by the type of spacer used and allows the injection system and the protective sheath (if applicable) to be positioned.

Injection method	Protection class		
	Temporary	Semi-permanent	Permanent
Gravity	A0	A1	A2
Global reinjection	A0	A1	A2
Selective reinjection	B0	B1	B2

Types of ground anchor

Temporary and semi-permanent strand anchors - The two types of ground anchors are distinguished by whether or not there is grease on the strands.

A0 and A1 ground anchors



Details

See technical data sheet

Free length

Greased (A1) or ungreased (A0) strands, individually sheathed.

Bond length

Bare strands with spacers, optional injection pipe(s) available.

Anchor foot

Strands assembled by fixing strip. Optional reinforced foot available.



B0 and B1 ground anchors



Details

See technical data sheet

Free length

Greased (B1) or ungreased (B0) strands, individually sheathed, with spacers for threading the tube à manchettes on site.

Bond length

Bare strands with spacers, optional injection pipe(s) available.

Anchor foot

Strands assembled by fixing strip. Optional reinforced foot available.



Other types

Removable ground anchors
Contact Freyssinet

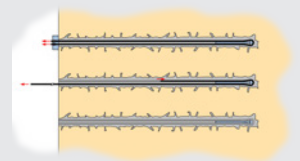

Sometimes the steel tendon have to be removed at the end of the project. This anchor allows a total extraction of the strands.

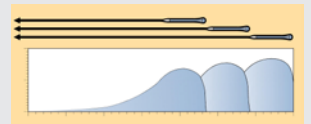

SBMA0 and SBMA1 ground anchors
Contact Freyssinet

Creation of several separate anchor zones on the same ground anchor

Anchor heads



P0 temporary head

This consists of an unpainted bearing plate, a block and jaws. It does not have any specific protection.



P2 standard permanent head

This consists of a painted bearing plate, a block and jaws. A wax-filled protective cap and trumpet tube provide permanent protection against corrosion.

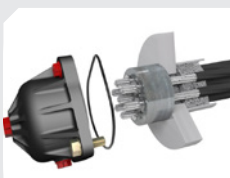

P1 semi-permanent head

This consists of an unpainted bearing plate, a block and jaws. A protective cap filled with grease or wax and a joint behind the plate provide semi-permanent protection.

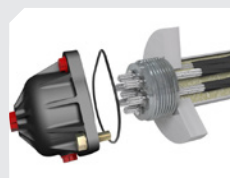

P2R retensionable permanent head

This consists of the same components as the P2 head, but the block is replaced with a threaded block.

Capacity of the anchor strand anchors

Unit	Steel grade MPa	Nom. cross-section mm ²	Weight of the strand kg/m	Elastic limit kN	Ultimate strength kN
4T15.3 4x0"6	1,650 / 1,860	560	4.40	916	1,040
7T15.3 7x0"6		980	7.70	1,603	1,820
9T15.3 9x0"6		1,260	9.90	2,061	2,340
13T15.3 13x0"6		1,820	14.30	2,977	3,380
4T15.7 4x0"62	1,650 / 1,860	600	4.72	984	1,116
7T15.7 7x0"62		1,050	8.26	1,722	1,953
9T15.7 9x0"62		1,350	10.62	2,214	2,511
13T15.7 13x0"62		1,950	15.34	3,198	3,627

Standard units (intermediate units are made by leaving one or more strand slots empty)

The most commonly used prestressing strands are 15.3 (0"6) and T15.7 (0"62), 1,860 MPa grade. However, other strands can be used (for example T12.5 (0"5) or T12.9 (0"52)).

The standard range is available with 2 to 13 strands, but larger capacity strand anchors can easily be produced on request.

The service load is calculated using the safety coefficients on the yield load or the ultimate load, specific to the applicable standard.

Permanent strand anchors – The principle of all permanent ground anchors is to create a sealed barrier between the strands and the ground using a sheath filled with cement grout. The cement therefore has the dual function of transmitting the forces from the cable to the sheath and then to the grouting, and protecting the strands against corrosion in the bond length.

A2 ground anchors



Details

See technical data sheet

Free length

Greased, individually sheathed strands contained in a corrugated plastic sheath.

Bond length

Bare strands with spacers, with a filling pipe in the corrugated sheath.

Anchor foot

Strands assembled by fixing strip. Optional reinforced foot available.

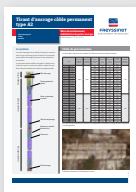

B2 ground anchors

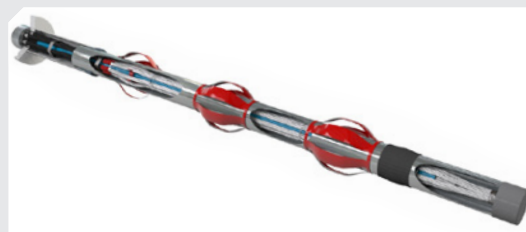

Details

See technical data sheet

Free length

Greased, individually sheathed strands contained in a metal tube.

Bond length

Bare strands with spacers contained in a metal tube.

Anchor foot

Strands assembled by fixing strip. Optional reinforced foot available.



Other types

Double sheathed strand anchors

Contact Freyssinet

Electrically insulated strand anchors

Contact Freyssinet

SBMA2 strand anchors

Contact Freyssinet

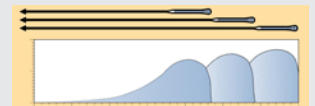

Creation of several separate anchor zones on the same ground anchor

Solutions for changing the angle

Bearing chair

This is adapted to the angle of the ground anchor and is positioned between the structure and the bearing plate.



Recess

The recess must be made before the wall is concreted.

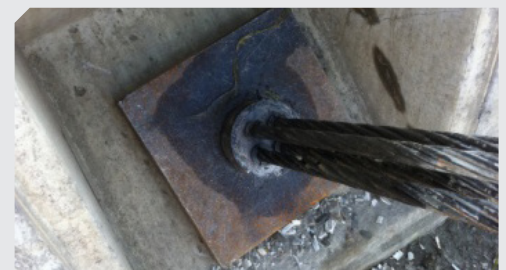

FREYSSIBAR ANCHORS

Temporary and semi-permanent Freyssibar anchors - The two types of Freyssibar anchors are distinguished by whether or not there is grease on the bar. These anchors have the advantage of being very simple to install.

Freyssibar anchor body

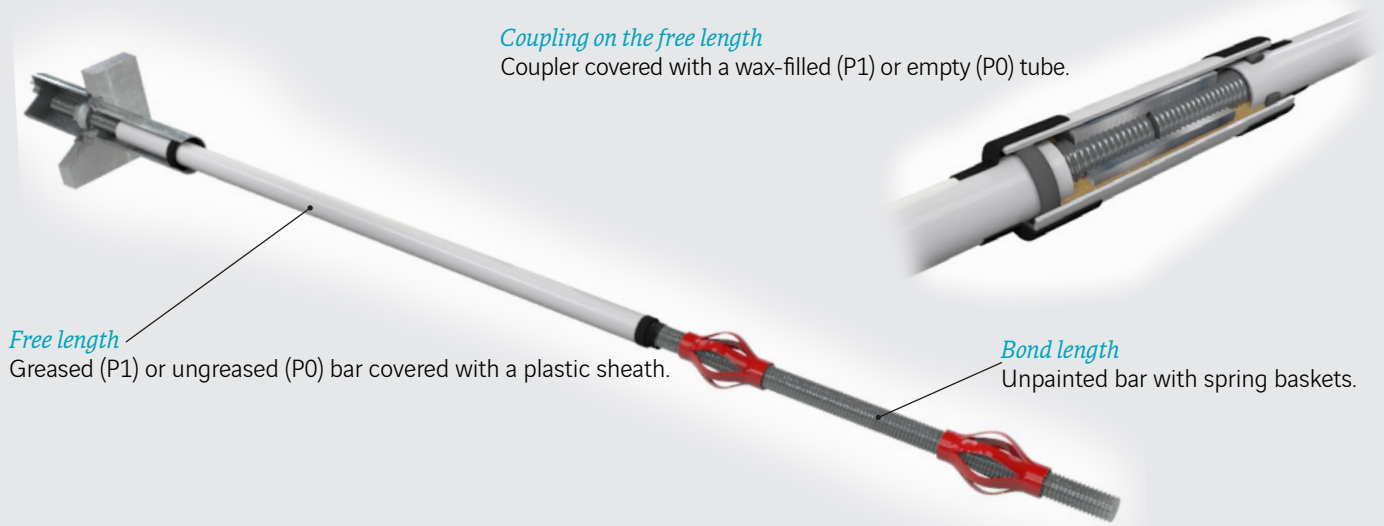

Fitting the injection system



Cross-section of the free length of the anchor with an injection pipe

The grout injection system is fitted beside the bar in all cases. All types of injection pipe can be used.



Cross-section of the bond length of the anchor with an injection pipe

Anchor heads



P0 temporary head

This consists of an unpainted bearing plate and a block. It does not have any specific protection.



P1 semi-permanent head

This consists of an unpainted bearing plate and a nut. A protective cap filled with grease and a joint behind the plate provide semi-permanent protection.

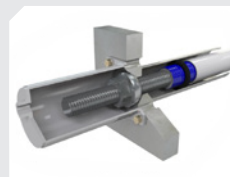

P2 standard permanent head

This consists of a painted bearing plate and a nut. A protective cap and a trumpet tube behind the plate, both filled with wax, provide permanent protection.

P2R retensionable permanent head

This has the same components as the standard head, apart from the cap, which is higher in order to support an overlength bar behind the nut. A jack can subsequently be mounted for tension adjustments or retensioning.

Permanent Freyssibar anchors - The Freyssibar permanent anchor is very easy to install and offers superior corrosion protection, since it is applied in the factory. It consists of a cement grout coating the bar completely, contained in a corrugated plastic sheath.

Freyssibar anchor body

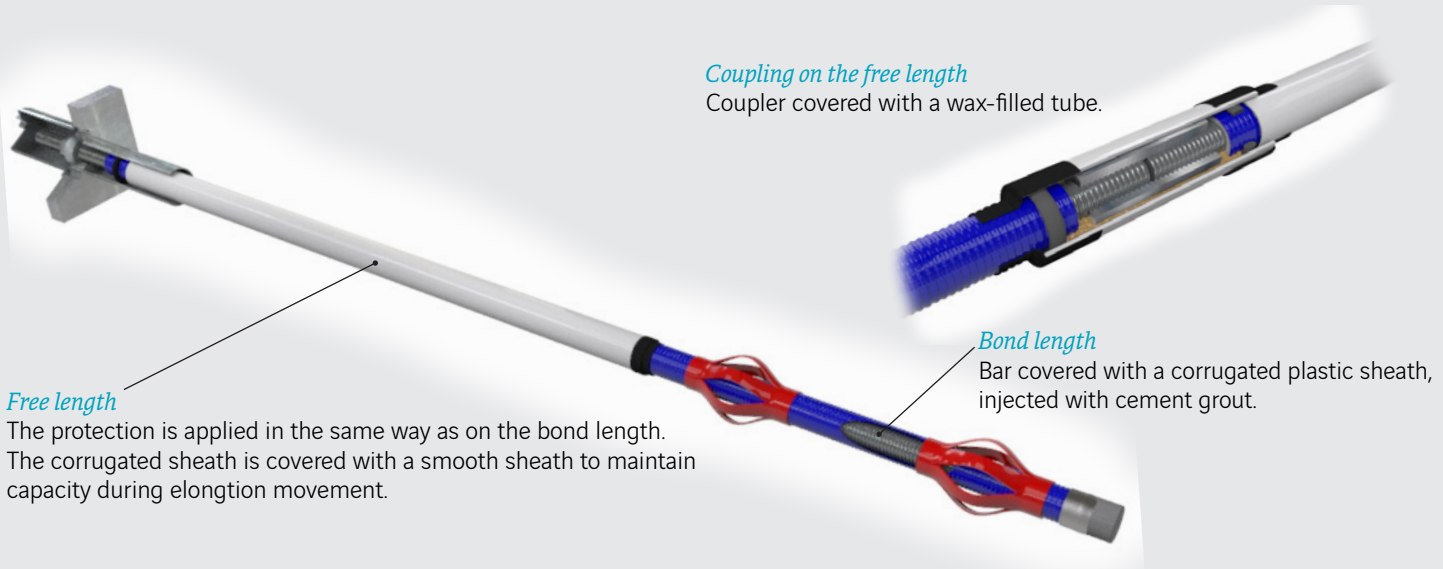

Fitting the injection system

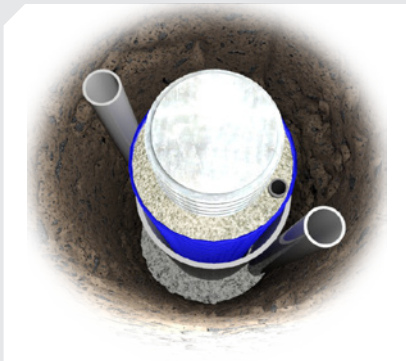

Cross-section of the free length of the anchor with an injection pipe

The grout injection system is fitted beside the bar in all cases. All types of injection pipe can be used.



Cross-section of the bond length of the anchor with an injection pipe

Solutions for changing the angle

Bearing chair

This is adapted to the angle of the tie rod and is positioned between the structure and the bearing plate.

Recess

The recess must be made before the wall is concreted.

Unit	Steel grade MPa	Nom. cross-section mm ²	Weight kg/m	Yield load kN	Ultimate load kN
26.5	835 / 1,030	552	4.56	461	568
32		804	6.66	672	828
36		1,018	8.45	850	1,048
40		1,257	10.41	1,049	1,295
50		1,964	16.02	1,640	2,022

Freyssibar range



FREYSSI500-E, FREYSSI670-E AND

Three types of bar

These Freyssinet bars are for similar uses and vary according to the steel grade and production site.

Please contact us to determine the range best suited to your project specifications.

Freyssi500-E		Nominal diameter mm	Grade MPa/MPa	Weight kg/m	Cross-section mm ²	Yield load kN	Ultimate load kN
Left-hand thread		16	St 500/550 (grade 75)	1.58	201	101	111
		20		2.47	314	157	173
		25		3.85	491	246	270
		28		4.83	616	308	339
		32		6.31	804	402	442
		40	9.87	1,257	629	691	
		50	15.40	1,963	982	1,078	
		63.5	St 550/700 (grade 80)	24.86	3,167	1,758	2,217

Freyssi670-E		Nominal diameter mm	Grade MPa/MPa	Weight kg/m	Cross-section mm ²	Yield load kN	Ultimate load kN
Right-hand thread		22	St 670/800 (grade 97)	2.94	375	251	300
		25		3.85	491	329	393
		28		4.83	616	413	493
		30		5.55	707	474	566
		35		7.55	962	645	770
		43		11.40	1,452	973	1,162
		57.5		20.38	2,597	1,740	2,078
		63.5	24.86	3,167	2,122	2,534	

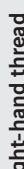
Freyssi500		Nominal diameter mm	Grade MPa/MPa	Weight kg/m	Cross-section mm ²	Yield load kN	Ultimate load kN
Right-hand thread		15	St 500/550 (grade 75)	1.47	177	88	97
		20		2.47	314	157	173
		25		4.10	491	245	270
		28		4.83	616	308	339
		32		6.65	804	402	442
		36		8.41	1,018	509	560
		40		10.34	1,257	628	691
		50		16.28	1,963	982	1,080
		63.5	St 550/700 (grade 80)	26.20	3,167	1,742	2,217

Advantages

All these bars have the following advantages:

- Rugged thread
- Self-cleaning continuous thread
- Weldable
- Bendable (allows many defaults of installation)

Accessories

Threaded components

There is a range of screw-on accessories for each type of bar:



- Hexagonal nut



- Spherical nut



- Coupler



- Anchor foot



- Lock nut

Plastic accessories

There is a range of plastic accessories for each type of bar:



- Spring baskets



- Injection pipes

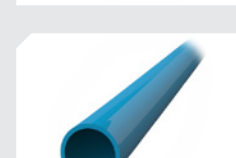

- Sheaths

FREYSSI500 SYSTEMS

Assemblies

The accessories can be used to build assemblies that are suited to numerous applications.

Anchor head

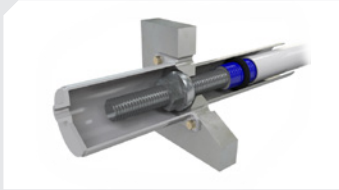

Head for permanent ground anchor



Head for soil nail and bolt

This consists of a nut and a plate. It can be fitted with a protective cap or a trumpet tube to provide corrosion protection.

Embedded anchor



Traction/compression anchor with plate
(low reinforcement in the concrete)



Traction/compression anchor with anchor foot
(specific reinforcement needed)

Embedded anchors can be used to create a simple, effective connection with a concrete structure (foundation slab, anchor block). It consists of a plate, a nut and a lock nut or an anchor component.

Coupling



Coupling with lock nut

A coupler is used for connecting two bars. In some cases, lock nuts are used to lock the coupler on the bar or reduce slipping of the thread when the reinforcement is subjected to stress.

Sheathing



Smooth sheath for free length

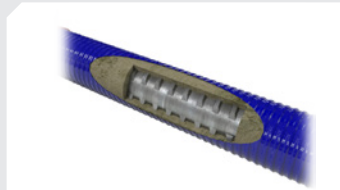

Double corrosion protection

The Freyssi500, Freyssi500-E and Freyssi670-E systems are used to create ground anchors; the bars are covered with a smooth sheath or a corrugated sheath injected with cement grout. The sheathing principle is the same as for Freyssibar temporary or permanent anchors (see pages 10 & 11).



Preparation of Freyssi500 soil nails - Martinique, France

FREYSSISD SYSTEM

Principle

This system is used to create anchors in soft or unstable ground. Drilling, positioning of the reinforcement and injection are carried out in a single operation, thereby avoiding the difficult task of drilling a casing hole.

A disposable drill bit is screwed onto the first bar. The bar is then connected directly to the drill shank (if necessary using an injection swivel). Drilling starts with simultaneous injection via the central hole in the bar. As the drill bit features a hole, the cement grout spreads into the ground as the drill moves forward. When the first bar is fully inserted in the ground, injection and drilling are stopped, and the bar is unscrewed from the drill shank. The second bar can then be coupled to the first bar and the machine, and the operation can be resumed.

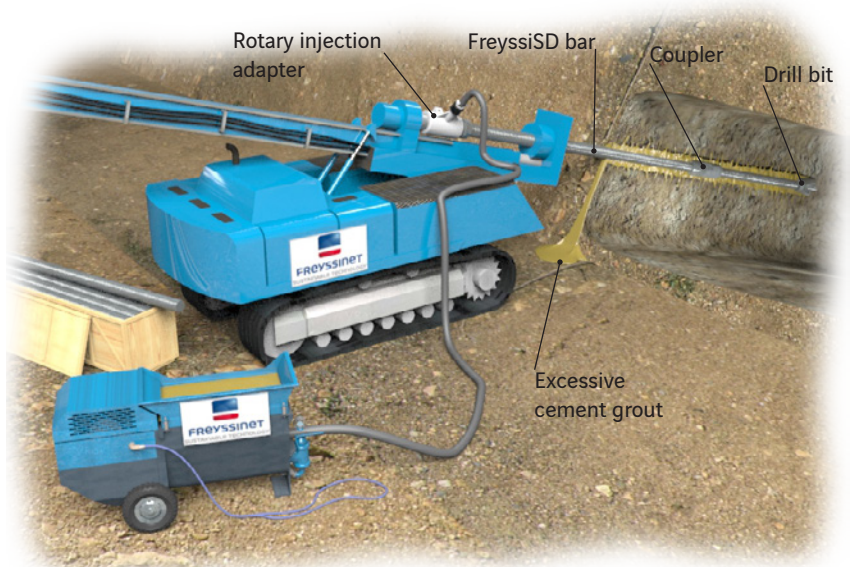

Simultaneous injection and drilling

Components



R thread	T thread
R25 N	T76 L
R32 N	T76 N
R32 S	T76 S
R38 N	
R51 L	
R51 N	

Threaded hollow bars (all lengths)

Hollow bars have a continuous external thread with an R (rope thread) or T (trapezoidal thread) profile.



Couplers

The bars are assembled together using couplers. A specially designed stopping system ensures that the coupler is correctly positioned on the bars to be coupled.



Nuts and plates

The plates and nuts are used to create the anchor head. There are straight nuts and spherical nuts, each with their appropriate plates.



Drill bits

A wide range of drill bits is available to suit all ground conditions and for various drill hole diameters. Please contact our Freyssinet specialists to help you choose the most suitable drill bit(s).



Drill adaptor tools

All drill connectors are available (injection swivels, sleeves, etc.). They have the anchor thread on one end and the thread of the drill shank on the other.

FREYSSICELL SYSTEM

Principle

FreyssiCell load cells have been developed for the instrumentation of ground anchors and prestressing anchors. They measure the force present in the tendon during the works and throughout the structure's service life.

The FreyssiCell system has a centralised metering unit which enables all the ground anchors fitted with cells in a structure to be monitored from a single workstation. Other data acquisition systems can be connected to the cells on request.

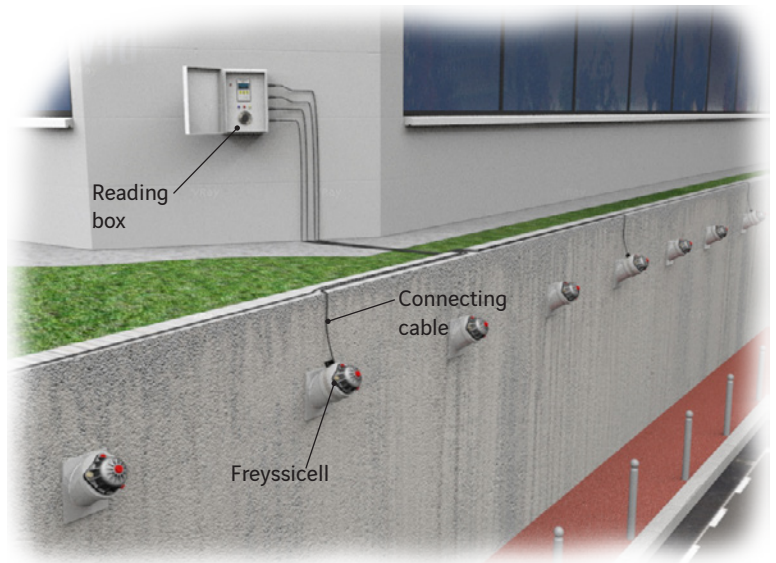

Connection to the components

Assembly

The cell is placed between the anchor plate and the bearing surface. Specially adapted plates are used to distribute the force. A locating washer ensures all the parts are correctly aligned.

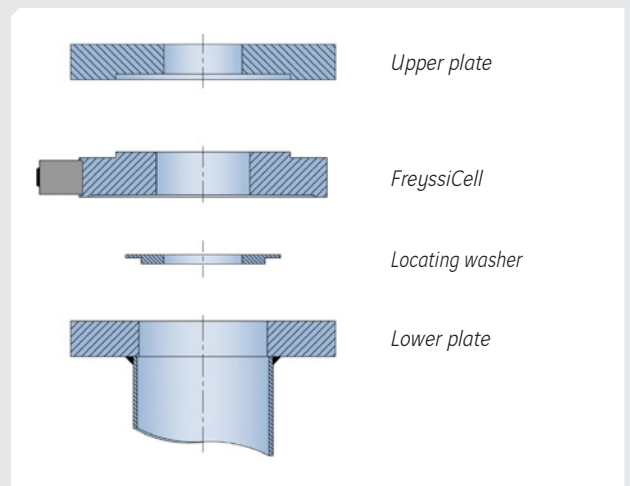

Range

The standard range covers all reinforcements (cable or bar). Specific models can be designed on request.

Model	Nominal force kN	Φ1 mm	Φ2 mm	D1 mm	Operating range	
					Cable	Freyssibar
FreyssiCell500	500	155	82	95	1 to 3C15	26.5
FreyssiCell750	750	155	82	95	2 to 3C15	32
FreyssiCell1000	1,000	155	82	95	2 to 4C15	36
FreyssiCell1700	1,700	220	100	155	5 to 7C15	40 - 50
FreyssiCell2200	2,200	260	144	190	8 to 9C15	
FreyssiCell2700	2,700	300	144	230	10 to 13C15	
FreyssiCell3100	3,100	340	160	230	10 to 13C15	

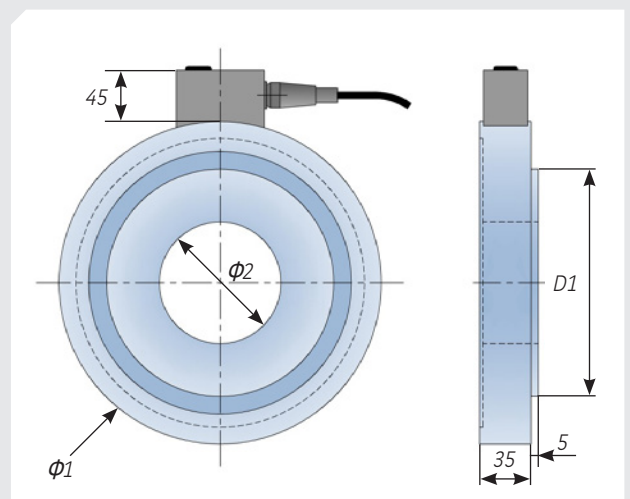

INJECTION SYSTEMS

The choice of injection method is vital, since it determines the strength of the anchorage in the ground and therefore its performance. It is determined by the geotechnical engineering office.

Type of ground	Increase in the IRS/IGU capacity
Sand and gravel	1.3 - 1.8
Marl and limestone	1.9 - 2.0
Clay	2.6 - 3.2
Silt	2.1 - 2.6
Soft rock	~ 1.3

This table is for information purposes only and provides an idea of the increase in strength of the grouting between an IRS injection and an IGU injection

Injection methods

The main criterion characterising injection is the control of the grouting injection zone. The cement grout is defined and provided by the installer, depending of the project specifications.

There are three injection methods:

- Gravity injection
- Global reinjection (IGU)
- Selective reinjection (IRS)

Gravity injection

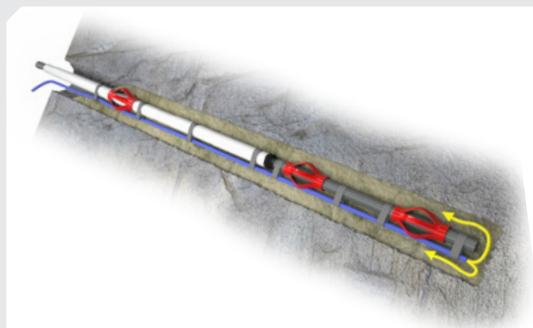

This method involves filling the bore hole with cement grout via the bottom. A filling pipe is installed along the anchor. Once the anchor has been inserted in the bore hole, the cement grout is injected via the tube until it reappears at the surface. In some cases, there is no injection pipe and the bore hole is filled with cement grout before the anchor is inserted.

The injection pressure corresponds to the pressure needed to form the column of grout.

This simple yet effective method provides acceptable anchorage strength in rock and compact sand, but is often inadequate in loose soil and clay. When the ground is fractured, the anchor can be fitted with a geotextile cover to prevent grout loss.

Global reinjection (IGU)

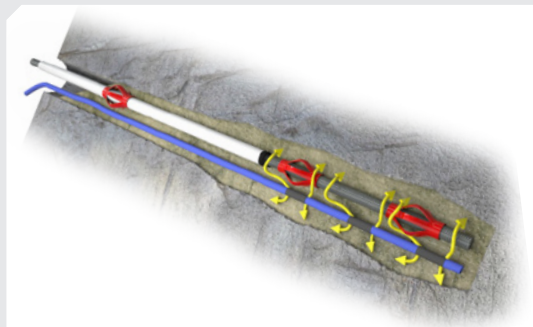

The aim is to inject cement grout into the anchor zone at a higher pressure than with gravity injection. The anchor is fitted with a reinjection pipe featuring sleeves and is closed at the end.

Gravity injection is carried out first. When the grout starts to set (10 to 24 hours after gravity injection), further injection is carried out via the reinjection pipe. The pressure of the grout "cracks" the cement grout that was injected in the first phase and increases the pressure in the required zone. The reinjection pipe has at least one sleeve per metre.

The pressure of the grout at the end of injection is generally between 10 bar and half the pressure limit for the ground.

This method is highly effective for ground anchors grouted in sand or compact ground and for passive anchors in all types of ground.

In some cases, it is used in fractured rock for reinjection into areas where grout has been lost.

Selective reinjection (IRS)

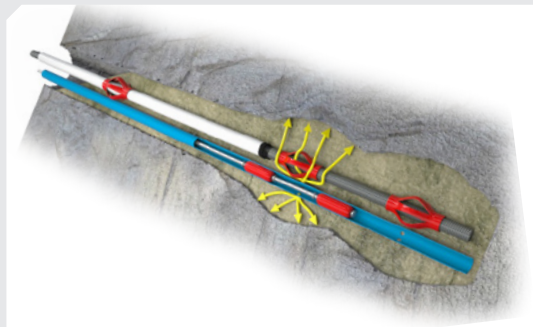

This method ensures perfect control over the injection volume and pressure in each grouting zone.

A sleeved reinjection pipe enabling a double packer to be inserted is installed along the anchor. After an initial gravity injection phase, reinjection is carried out using the double packer inserted in the sleeved reinjection pipe. The injection can thus be precisely controlled at each sleeve.

The pressure at the end of injection is generally higher than the pressure limit for the ground and may not exceed 40 bar.

ASSOCIATED SERVICES

On-site services

Teams of specialist technicians can work on-site to carry out all the operations associated with installing anchors, in accordance with the applicable standard. They are particularly trained to master creep movement and all other specific operations.

	Strand and bar ground anchors	Micropiles	Soil nails and bolts
Conformity tests	X	X	X
Inspection tests	X	X	X
Tensioning	X		
Head protection	X		
Consulting and expertise	X	X	X
Compression tests		X	
Controlled speed testing			X
Controlled displacement testing			X



Tensioning of strand anchor, Rosa Parks OA9, Paris



Micropile tests, Méliá tower, La Défense



Soil nail tests, Méliá tower, La Défense

Equipment

Specially designed equipment for installing ground anchors is available. It enables Freyssinet systems to be installed reliably and safely.

Uncoiler



Strand anchor uncoiler

The uncoiler is essential for installing cable anchor tie rods safely. It also protects the anchor body from dirt and any damage to the sheaths, and improves installation rates.

Frames



Frame for storage and transport

Frames are used to transport and store coiled strand anchors safely and protect from dirt.

Jacks for tests and tensioning

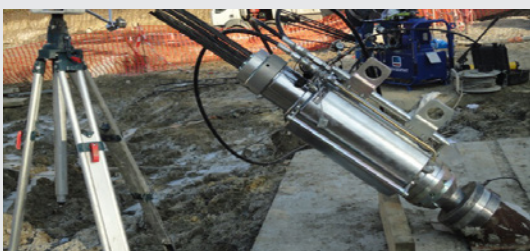

Tensioning jack

Whether for bars or cables, jacks are specially designed for Freyssinet systems. They are therefore an integral part of the anchorage system used.

REFERENCES



SBMA removable strand anchors - Phase II refurbishment of the Caritas Medical Centre - Hong Kong



Freyssibar micropiles - Saint Régis Hotel - Argentina



Tensioning strand anchors - International Convention Centre, Madrid - Spain



Preparation of a Freyssibar permanent anchor - Canadian Embassy, Rabat - Morocco



Freyssi500 soil nails - Morne Calebasse - France



Permanent strand anchors - Rosa Parks station - France



Self-drilling anchors, Batopilas Bridge - Mexico



Temporary strand anchors - Bangalore Metro - India

Freyssinet technical data sheets



All technical data sheets are available from Freyssinet.

PRODUCTION AND QUALITY

Approvals

All sensitive components (jaws, blocks, Freyssibar nuts & couplers, and prestressing steel) are covered by a technical approval and feature the CE marking. Approvals are issued after extensive testing and bear testament to the quality of our products.



Production and inspection

Like all products designed and made by Freyssinet, the components and finished products are subject to strict inspections based on the most stringent international standards. Freyssinet manages production and carries out quality control within its industrial subsidiary FPC (Freyssinet Products Company) based in France.

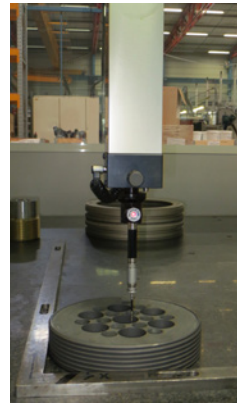

3D inspection of a threaded block



Production of permanent Freyssibar anchors

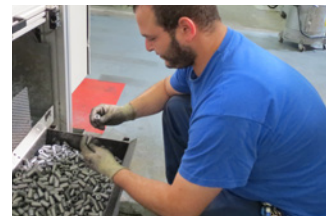

Manufacturing of jaws

Logistics

Centralised manufacturing and development of the components ensures total product expertise. The wide range of prefabrication and assembly sites provides the speed of response necessary for the successful completion of projects. Appropriate packaging is selected according to the destination of the products and the mode of transport used.

Freyssinet can handle road, sea and air transport to provide superior service to sites worldwide.

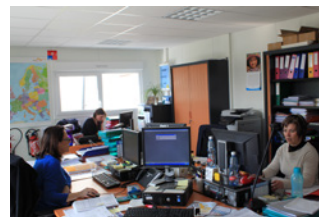

Logistics center



FreyssiSD stock

Traceability

All sensitive parts of the anchors (tendons, anchors, corrosion protection, etc.) are fully traceable.





Over 60 locations worldwide

THE AMERICAS. Argentina . Brazil . Canada . Chile . Colombia . United States . Mexico . Panama . Peru . Venezuela . EUROPE. Belgium . Bulgaria . Czech Republic . Estonia . France . Hungary . Ireland . Latvia . Lithuania . Macedonia . Netherlands . Poland . Portugal . Romania . Russia . Serbia . Slovenia . Spain . Switzerland . Turkey . United Kingdom . AFRICA AND MIDDLE EAST. Abu Dhabi . Algeria . Dubai . Egypt . Jordan . Kuwait . Morocco . Oman . Qatar . Saudi Arabia . Sharjah . South Africa . Tunisia . ASIA. Hong Kong . India . Indonesia . Japan . Macau . Malaysia . Pakistan . Philippines . Singapore . South Korea . Thailand . Vietnam . OCEANIA. Australia . New Zealand



FREYSSINET
SUSTAINABLE TECHNOLOGY

www.freyssinet.com